

FACTORY AUTOMATION

Mitsubishi Electric Sensorless Servo Global PM Motors EM-A Series





Automating the World



Our Factory Automation business is focused on "Automating the World" to make it a better, more sustainable environment supporting manufacturing and society, celebrating diversity and contributing towards an active and fulfilling role.

Mitsubishi Electric is involved in many areas including the following:

Energy and Electric Systems

A wide range of power and electrical products from generators to large-scale displays.

Electronic Devices

A wide portfolio of cutting-edge semiconductor devices for systems and products.

Home Appliance

Dependable consumer products like air conditioners and home entertainment systems.

Information and Communication Systems

Commercial and consumer-centric equipment, products and systems.

Industrial Automation Systems

Maximizing productivity and efficiency with cutting-edge automation technology.



The Mitsubishi Electric Group is actively solving social issues, such as decarbonization and labor shortages, by providing production sites with energy-saving equipment and solutions that utilize automation systems, thereby helping towards a sustainable society.

OVERVIEW

Concepts: Downsizing and energy savings; High performance; Globalization (International standard specifications)	4
Lineup/Specifications	10
Outline dimensional drawings	11
Wiring	13
Inverter	15
Drive module	17
Operation notes	18
Application examples	21
Warranty	22

1

2

3

4

5

6

7

8

9

Mitsubishi Electric Sensorless Servo Global PM Motors

EM-Aseries

For the EM-A Series, Mitsubishi Electric has developed a unique salient-pole core* to realize high-performance magnetic motors that can ensure positioning and speed control without a sensor.

*Patent No.: 5646119

Downsizing and energy saving



Globalization

High performance

Downsizing and energy saving

Problems

- Downsizing of equipment
- Energy saving

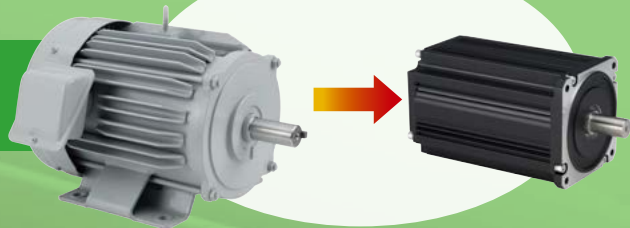

Solutions

- The motors use cores with optimum shapes for sensorless control, and the motor frame numbers are lower by 1 or 2 compared to induction motors. Then, the equipment can be downsized.
- The use of the magnetic motors meeting the efficiency class* IE5 for variable speed motors can promote energy saving.

* According to the efficiency reference values (%) for variable speed motors (rated speed 1801 to 6000 r/min) based on IEC60034-30-2.

High performance

Problems

- Improvement of equipment performance and cost reduction

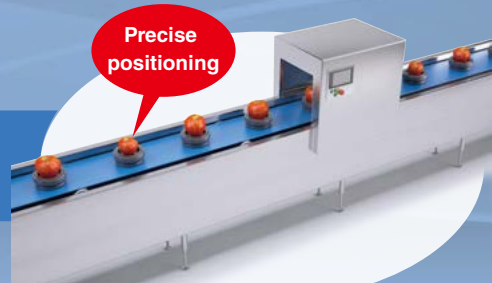

Solutions

- Mitsubishi Electric's unique sensorless control realizes precise speed control comparable to that of servo motors.
- Positioning control can be achieved without a sensor (encoder).

Globalization

Problems

- Use of the same motor in the equipment exported to various countries



Solutions

- Since the magnetic motors do not require*1 the high efficiency certification in each country, they can be easily used in the equipment to be exported.
- Conformance to international safety standards (UL/cUL, CE/UKCA) is also available.

*1: As of July 2023 (with partial compliance with China Energy Label Law (CEL 038-2020))

Downsizing and energy saving

Downsizing

- The motor core shape optimum for sensorless control realizes 50 to 60% reduction of volume and 30 to 50% reduction of mass compared to induction motors.

[Comparison of volume]

Induction motor (SF-PRF, 2P, 0.75 kW)

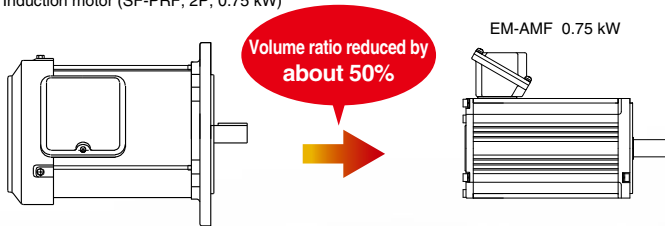

[Volume] When the volume of induction motors is 1

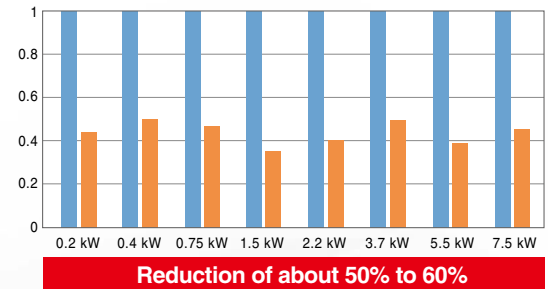

[Comparison of mass]

Induction motor (SF-PRF, 2P, 0.75 kW)

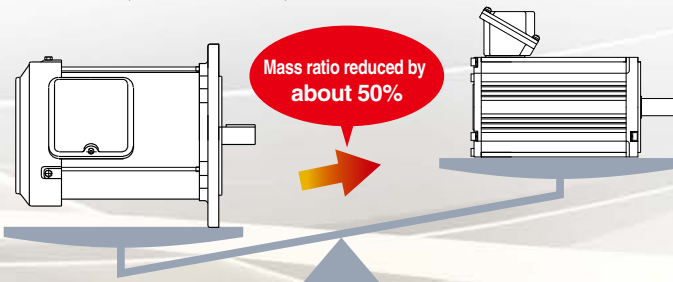

[Mass] When the mass of induction motors is 1

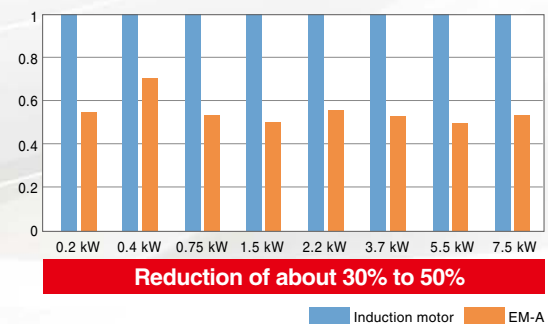

Energy saving

- Energy-saving motors meeting the efficiency class* IE5 for variable speed motors.

* According to the efficiency reference values (%) of variable speed motors based on IEC60034-30-2 (at the rated speed of 1801 to 6000 r/min).

* Representative data; values are not guaranteed.

Meeting the IE5 efficiency standard

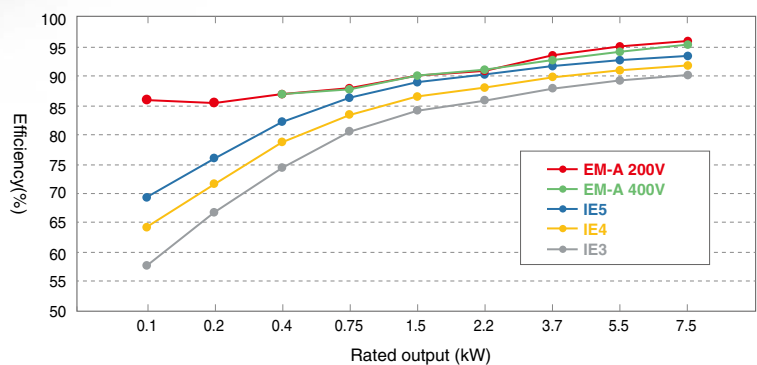

- The motors consume lower electric power and contribute to the reduction of energy charge, which reduces the CO₂ emission and contributes to the prevention of global warming.

<Estimation conditions>

Efficiency value when 10 motors are operated at the rated load for 8760 hr/year (= 24 hr/day × 365 days/year) with an electricity rate of 15 yen/kWh and CO₂ emissions of 0.42 kg/kWh

* This data is for reference only.

Energy-saving efficiency when using ten 3.7 kW motors

[Annual energy charge]

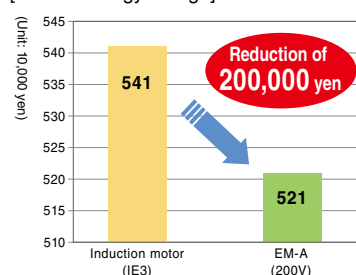

[Annual CO₂ emissions]

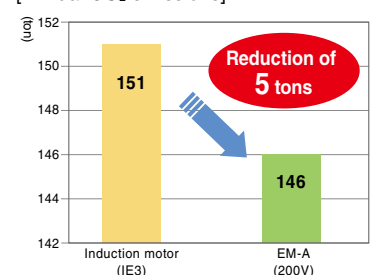

High performance

Mitsubishi Electric has developed a unique salient-pole core to achieve high-performance magnetic motors that can be controlled position and speed without a sensor.

1 Concepts: Downsizing and energy savings; High performance; Globalization (International standard specifications)

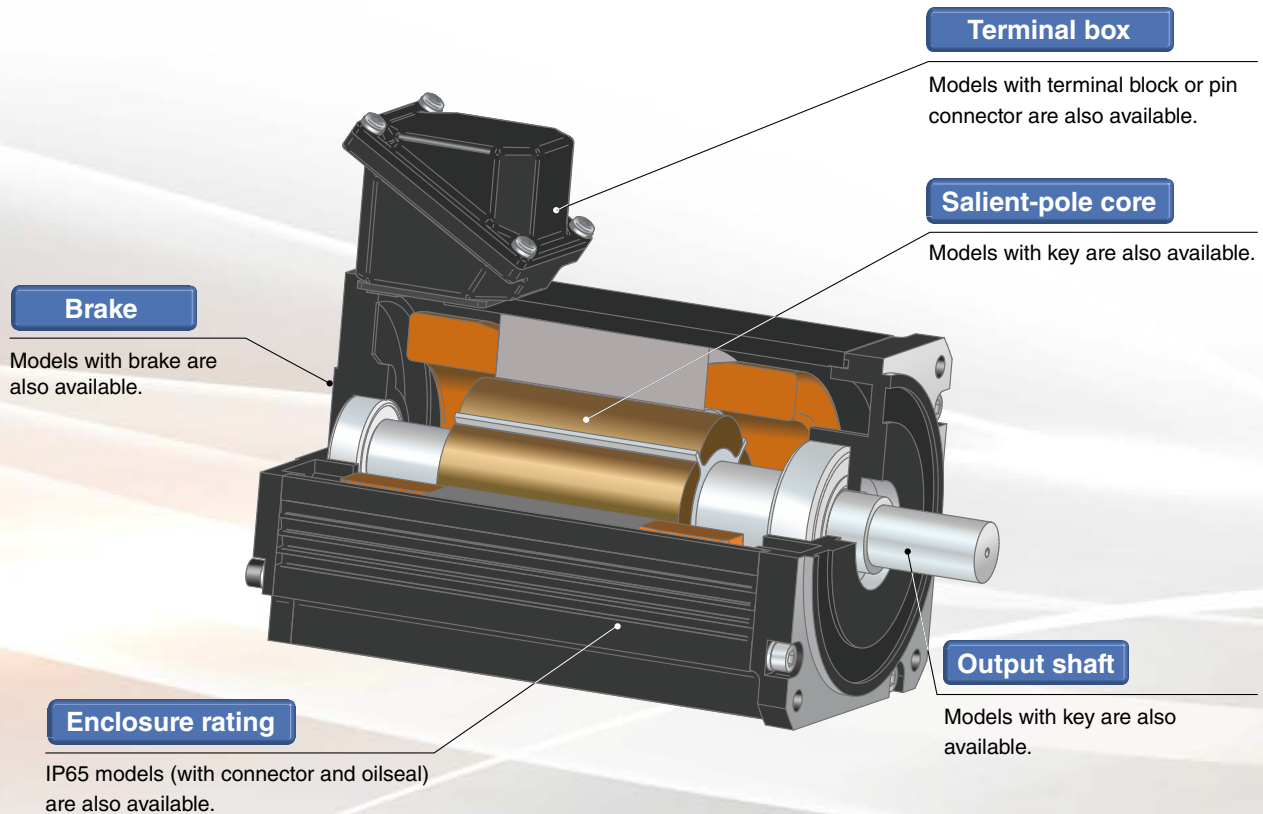

Newly developed salient-pole magnetic motors

EM-A series include newly developed magnetic motors using the patented salient-pole core^{*1}. The rotor consists of the salient-pole core and surface-mounted permanent magnet, and therefore the motor inductance changes depending on the rotational position. This change in inductance is applied to the sensorless control.

The combination of the newly developed salient-pole magnetic motor and Mitsubishi Electric's unique high-performance sensorless control technique enables high-accuracy speed control and position control without a sensor (encoder). ^{*1} Patent No. 5646119

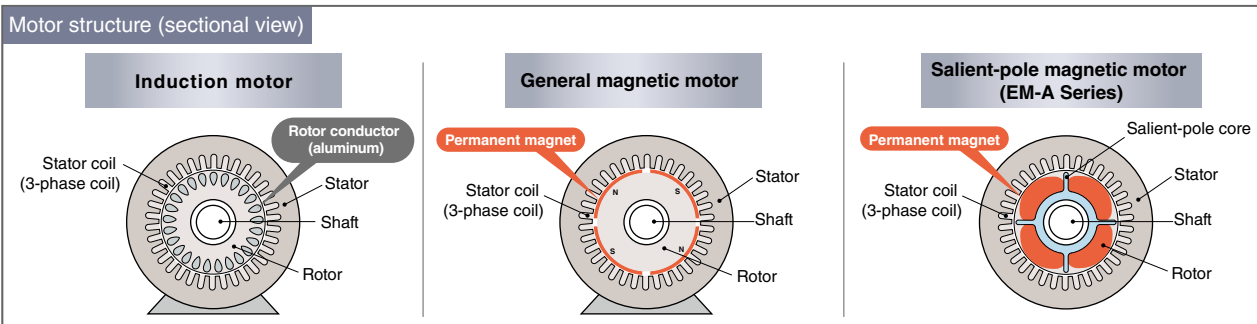

Speed control

Speed control comparable to servo motors is achieved without a sensor.

Speed variation ratio:
±0.05%
* In the case of digital input

Max. torque:
200%

- EM-A series realizes high-accuracy speed control by using Mitsubishi Electric's unique PM sensorless vector control that does not cause significant speed variations even under changing loads.
- EM-A series can be applied to high precision transfer systems of semiconductor and liquid crystal manufacturing lines.
- EM-A series can drive at stable speed ever when load fluctuates.

Speed variation ratio: ±0.05% *1
Speed control range: 1:1000

*1: When load changes between 0 and 100%

$$\text{Speed variation ratio} = \frac{\text{Actual rotation speed} - \text{command rotation speed}}{\text{Rated speed}} \times 100(\%)$$

- The servo lock function generates holding torque when the motor stops and can prevent movement by external force.

[Operating torque characteristics]

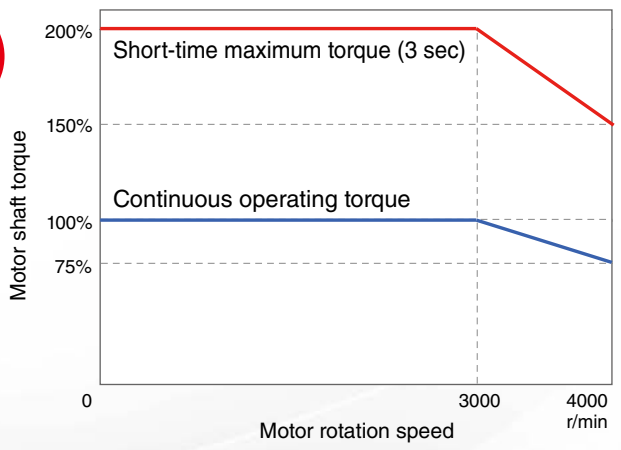

- * Torque characteristics may decline when the input voltage is low.
- * The continuous operating torque is 90% at 10 r/min or less (1.5 kW or more).
- * When high-load operation is performed in low-speed areas (in particular at 15 r/min or less (0.75 kW or less) or 10 r/min or less (1.5 kW or more)), the electronic thermal protector (E.THT or ETHM) may activate and it may not be possible to produce torque in the short-time operating area.
- * At low speeds (approx. 100 r/min or less), speed may be uneven due to torque ripples caused by magnetic attraction/repulsion forces of the motor.
- * The indicated maximum torque (200%) is for 3-phase inverter power specifications.

Positioning control

Positioning can be performed without a sensor.

- The combination of the newly developed salient-pole magnetic motor and Mitsubishi Electric's unique high-performance sensorless control technique enables high-precision speed control and positioning control without a sensor (encoder).
- The positioning function (point table method) using a contact signal and CC-Link communication (optional) can be used.*1
The use of the pulse-train input option*2 enables positioning by using a programmable controller positioning module.

Positioning accuracy:
200p/rev

Positioning accuracy: 200 p/rev *3
Inverter position command resolution: 4096 p/rev

*1: The function is not applicable to absolute position detection systems.
 *2: FR-A7AP-EX kit (Only compatible with the FR-E700EX Series)
 *3: See the inverter instruction manual for wiring length requirements.

Globalization

EM-A series magnetic motors do not require the high efficiency certification in each country and can be easily applied to equipment to be exported.

High efficiency regulations in each country

In 2008, the efficiency classification for induction motors (IEC60034-30) was established as an international standard, and the certification system for high efficiency regulations has been set up in each country. In the future, the high efficiency regulations will be globally applied, and it will be required to acquire the certification.

Country/region	Laws/standards	Motor efficiency class	EM-A Series
China	CEL007-2021-GB18613-2020	Grade GB3 or higher	Not applicable
US	EISA-NEMA MG1-12-12	IE3	
Canada	EEAct-CSA C390	IE3	
EU	(EU)2019/1781-IEC60034-30-1(2014)	IE3	
Australia	GEMS Determination 2019-AS/NZ1359.5:2004	IE2 and IE3	
New Zealand			
Taiwan	Chinese National Standard (CNS) 14400	IE3	
Korea	KSC 4202	IE3	
Brazil	Presidential Order 4508-ABNT NBR 17094-1	IE2	
Vietnam	No.51/2011/QĐ-TTg, TCVN 6627-30:2011 TCVN 7540-1:2013	IE1	
Mexico	NOM-016-ENER-2016	IE3	
Saudi Arabia	SASO IEC 60034-30:2013 (IEC 60034-30 Ed.1.0:2008)	IE3	
India	IS 12615:2018 Energy Efficient Induction Motors- Three Phase Squirrel Cage	IE2	
Singapore	IEC 60034-2-1:2014(method 2-1-1B) or IEEE 112:2004(method B)	IE3	

* Information current as of August 2023.

* Although based on highly accurate information, the information presented here is not guaranteed.

High-efficiency regulations for synchronous motors

In April 2020, the Chinese government enacted the Implementation Rules for Energy Efficiency Labeling of Permanent Magnet Synchronous Motors (CEL 038-2020) requiring permanent magnet synchronous motors to display energy efficiency labels—as with induction motors—as of July 2020. International standards specification EM-A Series devices comply with this law.

Country/region	Laws/standards	Motor efficiency class	EM-A Series
China	CEL 038-2020, GB 30253-2013	Grade GB3 or higher	Applicable

* Information current as of August 2023.

* Compliance available only with 200 V class models. (Compliance planned for 400 V class.)

* Applicable for 0.75 kW or higher specifications without brake.

International standards specification

Compliance with UL/cUL, CE/UKCA marking, and China Energy Label (CEL) requirement!

Differences from standard products

- Adoption of materials and components that conform to each standard
- 155 (F) heat resistance class for all capacities
- Standard compliance marking on rating nameplate
- China Energy Label included on all CEL-compliant products



International standards compliance

○: Compliant x: Not compliant —: Not applicable

Model	EM-AMF(K)(W)			EM-AMF(K)T			EM-AMFB(K)(W)			EM-AMFB(K)T		
	UL/cUL	CE/UKCA	CEL	UL/cUL	CE/UKCA	CEL	UL/cUL	CE/UKCA	CEL	UL/cUL	CE/UKCA	CEL
0.1kW	○	○	—	○	○	—	○	○	—	○	○	—
0.2kW	○	○	—	○	○	—	○	○	—	○	○	—
0.4kW	○	○	—	○	○	—	○	○	—	○	○	—
0.75kW	○	○	○	○	○	○	○	○	—	○	○	—
1.5kW	○	○	○	○	○	○	○	○	—	○	○	—
2.2kW	○	○	○	○	○	○	○	○	—	○	○	—
3.7kW	○	○	○	x	x	x	○	○	—	x	x	—
5.5kW	○	○	○	x	x	x	○	○	—	x	x	—
7.5kW	○	○	○	x	x	x	○	○	—	x	x	—

* 400 V class models available only as 0.4 kW or higher.

* CEL compliance available only with 200 V class models. (Compliance planned for 400 V class.)

Compatible with wide range of voltages!

Compatibility with a wide range of voltages, one motor can be used in various regions around the world.

Motor voltage class	Inverter power supply specification	Inverter input voltage/frequency
200V	3-phase 200 V	3-phase 200 to 240 V, 50/60 Hz
	Single-phase 200 V	Single-phase 200 to 240 V, 50/60 Hz
	Single-phase 100 V	Single-phase 100 to 120 V, 50/60 Hz
400V	3-phase 400 V	3-phase 380 to 480 V, 50/60 Hz

Special specifications also available!

Waterproof specifications (IP65) and terminal block* models and models with terminal box socket directionality are also separately available.

* Terminal block models are limited to 2.2 kW or less.

Mitsubishi Electric Global FA Centers

Mitsubishi Electric offers full-fledged global factory automation services through dedicated staff with extensive experience and advanced technical skills across the globe. Customers can enjoy top-of-the-line service and support from any of our numerous support locations.

EMEA

- MITSUBISHI ELECTRIC EUROPE B.V. Polish Branch
- MITSUBISHI ELECTRIC EUROPE B.V. German Branch
- MITSUBISHI ELECTRIC EUROPE B.V. UK Branch
- MITSUBISHI ELECTRIC EUROPE B.V. Czech Branch
- MITSUBISHI ELECTRIC EUROPE B.V. Italian Branch
- MITSUBISHI ELECTRIC TURKEY ELEKTRIK URUNLERI A.S.

Asia-Pacific

China

- MITSUBISHI ELECTRIC AUTOMATION (CHINA) LTD. Beijing FA Center
- MITSUBISHI ELECTRIC AUTOMATION (CHINA) LTD. Guangzhou FA Center
- MITSUBISHI ELECTRIC AUTOMATION (CHINA) LTD. Shanghai FA Center
- MITSUBISHI ELECTRIC AUTOMATION (CHINA) LTD. Tianjin FA Center
- SETSUYO ENTERPRISE CO., LTD.

Korea

- MITSUBISHI ELECTRIC AUTOMATION KOREA CO., LTD.

Thailand

- MITSUBISHI ELECTRIC FACTORY AUTOMATION (THAILAND) CO., LTD.

ASEAN

- MITSUBISHI ELECTRIC ASIA PTE. LTD.

Malaysia

- Malaysia FA Center

Indonesia

- PT. MITSUBISHI ELECTRIC INDONESIA Cikarang Office

Vietnam

- MITSUBISHI ELECTRIC VIETNAM COMPANY LIMITED Hanoi Branch Office
- MITSUBISHI ELECTRIC VIETNAM COMPANY LIMITED

Philippines

- MELCO Factory Automation Philippines Inc.

India

- MITSUBISHI ELECTRIC INDIA PVT. LTD. Ahmedabad Branch
- MITSUBISHI ELECTRIC INDIA PVT. LTD. Bangalore Branch
- MITSUBISHI ELECTRIC INDIA PVT. LTD. Chennai Branch
- MITSUBISHI ELECTRIC INDIA PVT. LTD. Coimbatore Branch
- MITSUBISHI ELECTRIC INDIA PVT. LTD. Gurgaon Head Office
- MITSUBISHI ELECTRIC INDIA PVT. LTD. Pune Branch

Americas

USA

- MITSUBISHI ELECTRIC AUTOMATION, INC.

Mexico

- MITSUBISHI ELECTRIC AUTOMATION, INC. Mexico Branch
- MITSUBISHI ELECTRIC AUTOMATION, INC. Queretaro Office
- MITSUBISHI ELECTRIC AUTOMATION, INC. Monterrey Office

Brazil

- MITSUBISHI ELECTRIC DO BRASIL COMERCIO E SERVICOS LTDA.

Lineup/Specifications

Lineup

● Motor only

EM EM: Global PM motor	A A: A series	M M: Motor only	F F: Flange type	B None: Without brake B: With brake	K None: Without key K: With key	None: IP44 W: IP65 T: With terminal block ¹	
				Output 0.1 to 7.5kW ²	Rotation Speed 3000 r/min	Voltage 200 V class 400 V class	Special specification Terminal box socket direction International standards specification ³

*1: For details, see p. 13.

*2: 400 V class models available only as 0.4 kW or higher.

*3: For details, see p. 8 and 9.

Specifications

● Common EM-A motor specifications

Output (kW)	0.1 ⁴	0.2 ⁴	0.4	0.75	1.5	2.2	3.7	5.5	7.5		
Motor frame number	50Fr		63Fr		71Fr		100Fr				
Flange angle size	□90		□110		□125		□176				
Number of poles	4				6						
Rated frequency (Hz)	100				150						
Rated motor rotation speed(r/min)					3000						
Max. motor rotation speed(r/min)					4000						
Motor rated torque(Nm)	0.32	0.64	1.27	2.39	4.78	7.0	11.8	17.5	23.9		
Motor max. torque(%)	200 ⁵										
Positioning accuracy(p/rev)	200 ⁶										
Rating	Continuous										
Allowable output shaft overhang load (N) ⁷	392		490		686		1470				
Allowable output shaft thrust load (N)	196		294		490		980				
Heat resistance class	130(B)						155(F)				
Moment of inertia J (×10 ⁻⁴ kg·m ²)	Without brake		1.51	1.51	3.72	5.43	11.4	16.5	62.0	85.5	109
	With brake		1.53	1.53	4.03	5.74	12.2	17.3	66.5	90.0	113.5
Recommended moment of load inertia ratio	10 times or less										
Enclosure rating	Indoor type (IP44) ⁸ , Dust and waterproof type (IP65) ^{8,9}										
Enclosure structure	Totally-enclosed self-cooling type										
Ambient temperature/relative humidity	0 to +40°C / RH 90% or less										
Altitude	Up to 1000 m above sea level										
Vibration	Constant 4.9 m/s ² , instantaneous 9.8 m/s ² or less										
Brake specifications	DC spring holding type (24 V DC) (Brake torque 150% or more/allowable number of braking operations 1000 times/ mechanical life 1,000,000 times)										
Paint color	Black (equivalent to Munsell N1.5)										
Weight(kg)	Without brake		2.9	2.9	4.9	6.4	9.5	11.7	22	28	34
	With brake		3.9	3.9	6.7	8.2	12.2	14.4	28	34	40

*4: 200 V class only.

*5: Excluding single-phase input.

*6: See the inverter instruction manual for wiring length requirements.

*7: With load position at the center of the output shaft.

*8: Excluding the part where the shaft passes through.

*9: With EM-AMF□□V

○: Supported —: Not applicable

200 V class	Output (kW)		0.1	0.2	0.4	0.75	1.5	2.2	3.7	5.5	7.5
	Supported inverter	Capacity (□K)		0.1	0.2	0.4	0.75	1.5	2.2	3.7	5.5
FR-E720EX-□K ¹⁰			○	○	○	○	○	○	○	—	—
R-E820-□K ¹⁰			○	○	○	○	○	○	○	○	○
FR-E820S-□K ¹⁰			○	○	○	○	○	○	—	—	—
	FR-E810W-□K ¹⁰		○	○	○	○	—	—	—	—	—
	Motor rated voltage(V)		130	135	160	165	170	165	160	170	165
	Motor rated current(A)		0.55	1.1	1.8	3.3	6.1	9.3	16.5	22	31
400 V class	Output (kW)		0.4	0.75	1.5	2.2	3.7	5.5	7.5		
	Supported inverter	Capacity (□K)	0.4	0.75	1.5	2.2	3.7	5.5	7.5		
		FR-E840-□K ¹⁰		○	○	○	○	○	○		
		Motor rated voltage(V)	320	330	340	330	320	340	330		
	Motor rated current(A)	0.9	1.7	3.1	4.7	8.3	11	15.5			

*10: Be sure to perform initial setup of PM parameters (Pr.998) when using an EM-A motor for operation. See the inverter instruction manual for details.

Outline dimensional drawings

Outline dimensional drawings (Common for 200 V and 400 V class models)

● Without brake

EM-AMF 0.1kW

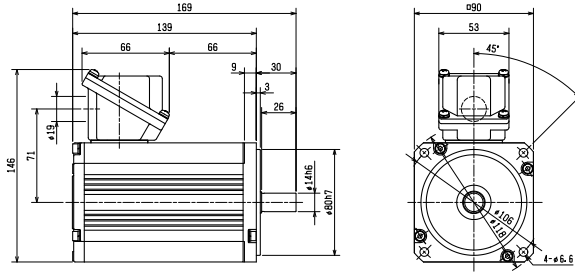

EM-AMF 0.2kW

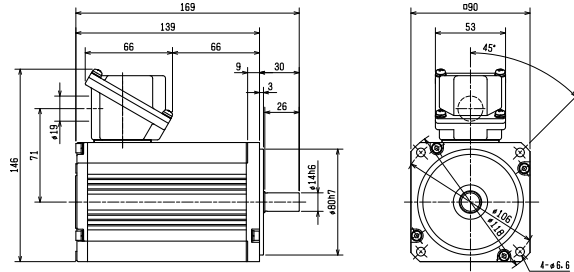

EM-AMF 0.4kW

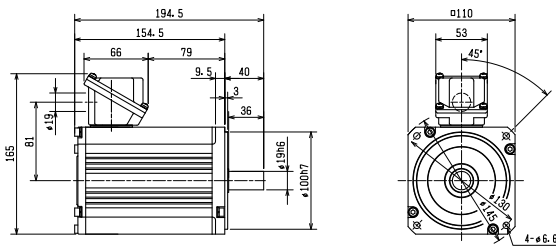

EM-AMF 0.75kW

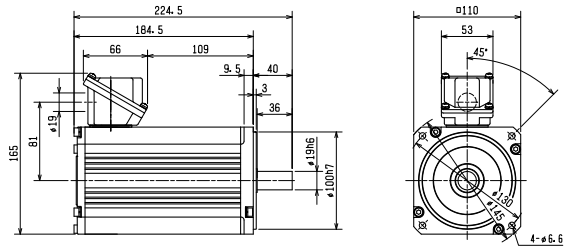

EM-AMF 1.5kW

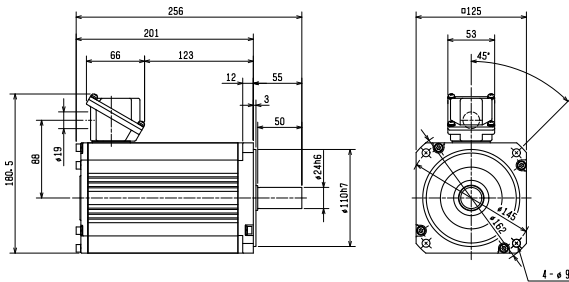

EM-AMF 2.2kW

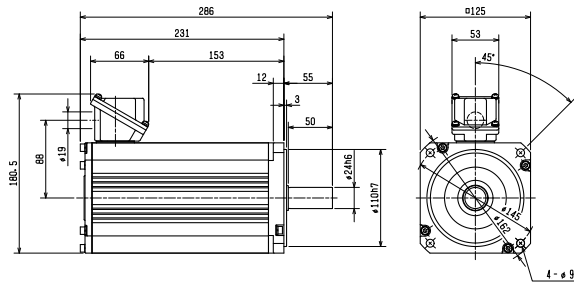

EM-AMF 3.7kW

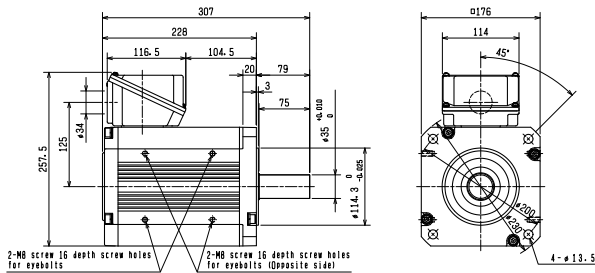

EM-AMF 5.5kW

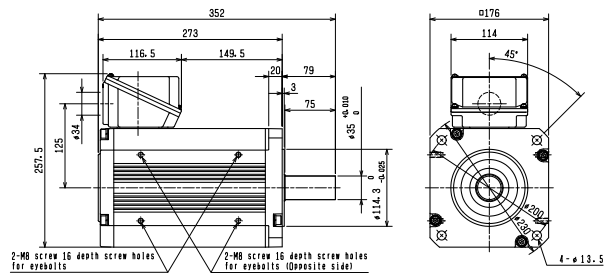

EM-AMF 7.5kW

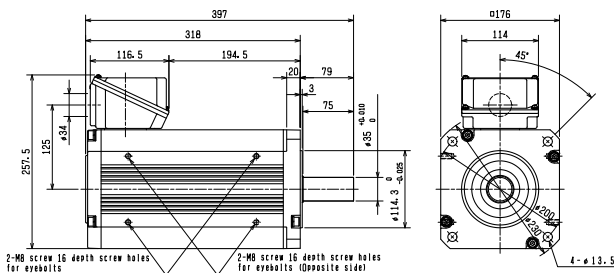

Outline dimensional drawings

● With brake

EM-AMFB 0.1kW

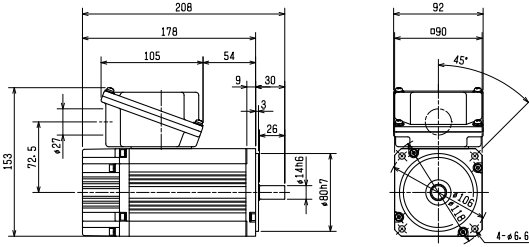

EM-AMFB 0.2kW

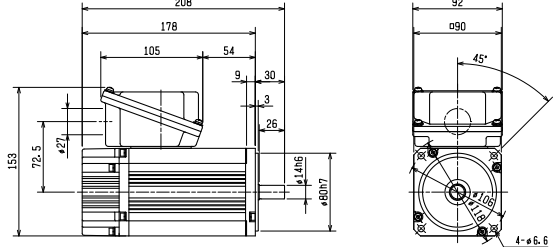

EM-AMFB 0.4kW

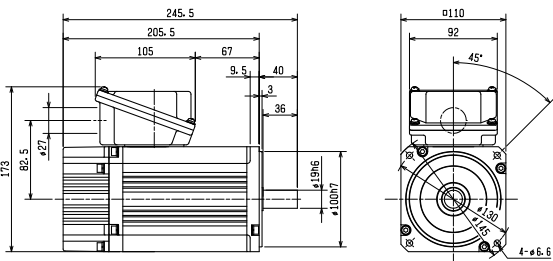

EM-AMFB 0.75kW

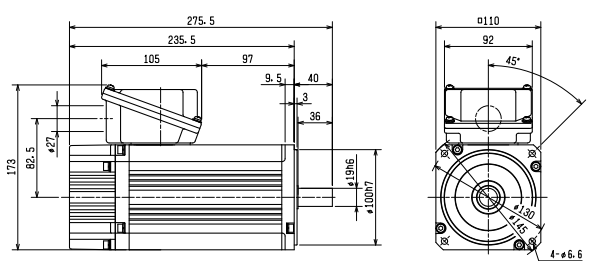

EM-AMFB 1.5kW

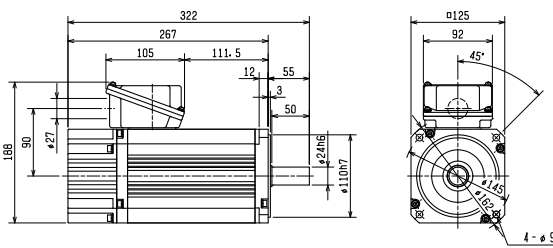

EM-AMFB 2.2kW

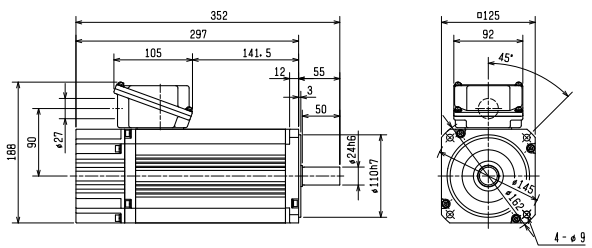

EM-AMFB 3.7kW

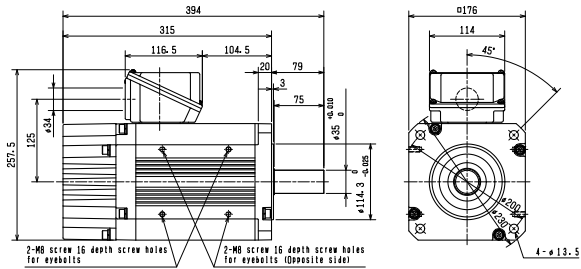

EM-AMFB 5.5kW

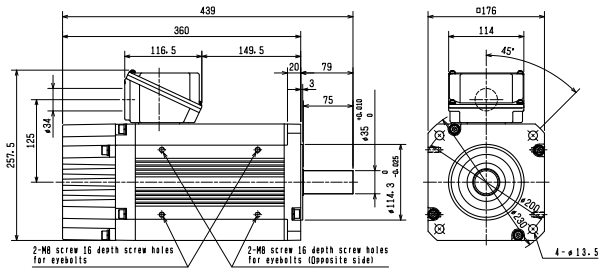

EM-AMFB 7.5kW

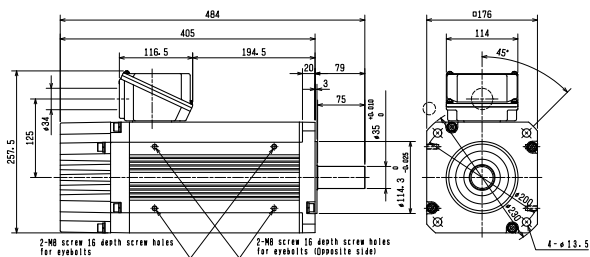

Motor wiring

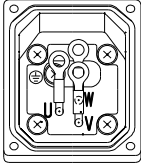
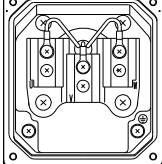
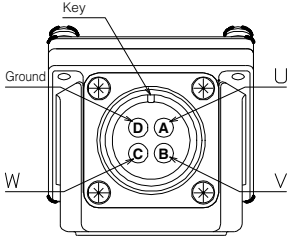
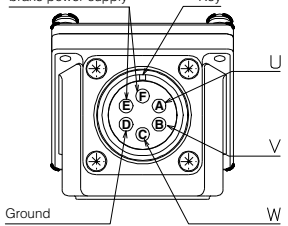
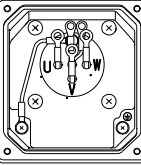
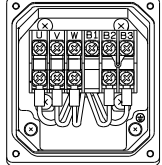
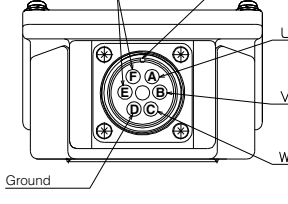
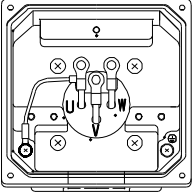
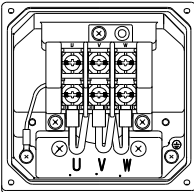
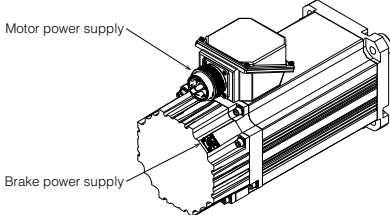
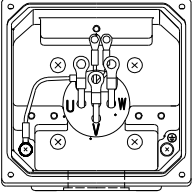
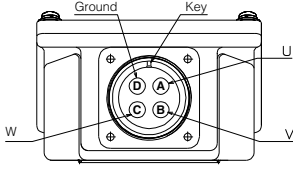
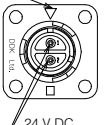
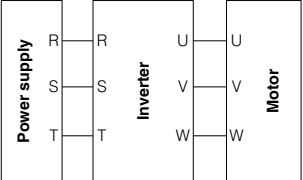
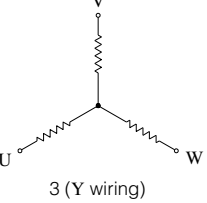
Model	EM-AMF(B)(K)	EM-AMF(B)(K)T	EM-AMF(K)W	EM-AMFB(K)W
Wiring type	Lug	Terminal block	Connector	
0.1 to 2.2 kW	Without brake 	Without brake ^{*1} 	 Connector: CE05-2A18-10PD-D	0.1 to 0.75 kW 1.5, 2.2 kW (400 V) 24 V DC brake power supply  Connector: CE05-2A18-12PD-D
	With brake 	With brake ^{*1} 		1.5, 2.2 kW (200 V) 24 V DC brake power supply  Connector: CE05-2A20-15PD-D
3.7 to 7.5 kW	Without brake 	Without brake ^{*2} 	 Motor power supply Brake power supply	
	With brake 		 Motor connector: 3.7, 5.5 kW: CE05-2A22-22PD-D 7.5 kW: CE05-2A32-17PD-D	 Brake connector: CMV1-R2P
Motor wiring method			Number of outgoing wire terminals	
			 3 (Y wiring)	

*1: For international standard products, the terminal block is the same without or with a brake.

*2: Terminal block models of international standard products are limited to 2.2 kW or less.

Brake wiring

● Lug model

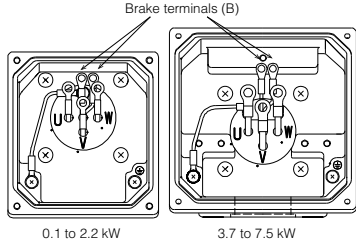
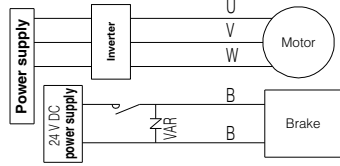
Terminal drawer structure	Connection diagram
 <p>0.1 to 2.2 kW 3.7 to 7.5 kW</p>	
	Motion delay time: 0.01 to 0.04 s

● Terminal block model

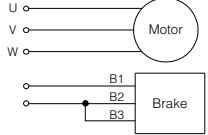
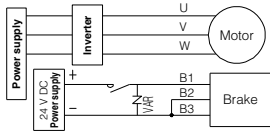
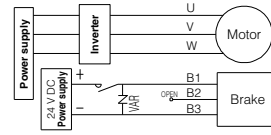
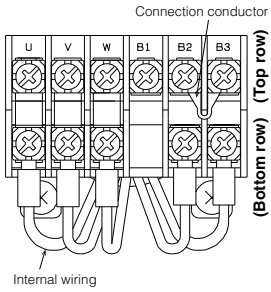
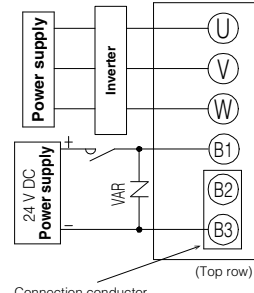
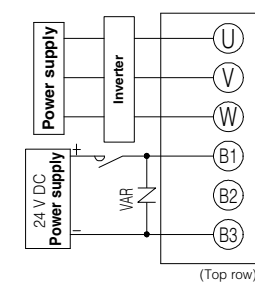
Shipped	Separation switching	DC switching (fast switching)
 <p>Circuit</p>		
 <p>Connection diagram</p>		
Motion delay time	0.1 to 0.3 s	0.01 to 0.04 s

● Connector model

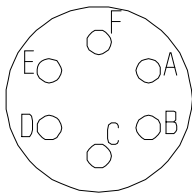
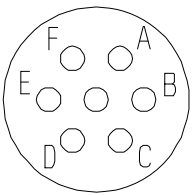
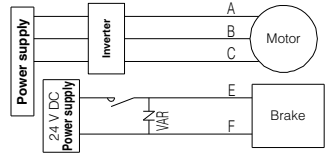
Connector pin assignment		Connection diagram
0.1 to 0.75 kW	1.5 kW, 2.2 kW	
		
<p>A: Power supply (U) B: Power supply (V) C: Power supply (W) D: Ground E, F: Brake power supply (24 V DC)</p>		Motion delay time: 0.01 to 0.04 s

Precautions

- (1) For terminal block models, connect the positive (+) side of the 24 V DC power supply to B1, and the negative (-) side to B3.
- (2) When using DC switching (fast switching), remove the connection conductor from the terminal block as shown in the figure above.
- (3) The terminal block has a top and bottom row. Be sure to connect the motor and brake power supply wiring to the terminal screws on the top row shown in the figure above.
- (4) No manual release mechanism is included. Electrically release the electromagnetic brake by supplying 24 V DC power.
- (5) Note that power factor correction capacitors cannot be used in the motor circuit.
- (6) When applying the brake, set the brake to operate after rotation of the motor has stopped.
- (7) See the instruction manual for surge absorber (varistor) selection examples.

FREQROL-E800

High-performance inverter in the smallest class



Lineup

FR - E8 [2] [0] [] - [] [0] [.] [1] [K] [] [] [] - [1] [] [] []

Symbol	Voltage class	Symbol	Structure/functions
1	100V	0	Standard components
2	200V		
4	400V		
Symbol	Voltage specification	Symbol	Voltage specification
(Blank)	3-phase	S	Single-phase 200 V input
		W	Single-phase 100 V input (Voltage doubler rectifier)
Symbol	Description		
0.1K to 7.5K	Applicable motor capacity (ND) (kW) ^{*1}		
0008 to 0330	Inverter ND rated current (A)		

Symbol	Communications/functional safety specifications
(Blank)	RS-485+SIL2/PLd
E	Ethernet+SIL2/PLd
SCE ^{*2}	Ethernet+SIL3/PLe

Symbol	Monitor/protocol specifications	Rated frequency	Symbol	Coating specification
-1	Pulse (FM)	60Hz	(Blank)	No coating
-4	Voltage (AM)	50Hz	-60	With coating
-5	Voltage (AM)	60Hz		
PA	Protocol group A (CC-Link IE TSN, CC-Link IE Field Network Basic, MODBUS/TCP, EtherNet/IP, BACnet/IP)	60Hz		
PB	Protocol group B (CC-Link IE TSN, CC-Link IE Field Network Basic, MODBUS/TCP, PROFINET)	50Hz		
PC ^{*2}	Protocol group C (EtherCAT)	50Hz		

For details of the lineup, contact our sales office.

*1: 0.4K to 7.5K for 400 V class
*2: Release of SCEPC planned

CC-Link IE TSN

EtherNet/IP

PROFINET

EtherCAT

EAC

TUV

UL

CE

UK

CA

Capacity

○: Available model —: Not applicable

Model	Applicable motor capacity (ND rating) [kW]									
	0.1	0.2	0.4	0.75	1.5	2.2	3.7	5.5	7.5	
3-phase 200 V FR-E820-□K	○	○	○	○	○	○	○	○	○	
3-phase 400 V FR-E840-□K	—	—	○	○	○	○	○	○	○	
Single-phase 200 V FR-E820S-□K	○	○	○	○	○	○	—	—	—	
Single-phase 100 V FR-E810W-□K	○	○	○	○	—	—	—	—	—	

Rating

3-phase 200-V power supply
3-phase 400-V power supply

3-phase 200-V power supply

Model name: FR-E820-[]		0.1K	0.2K	0.4K	0.75K	1.5K	2.2K	3.7K	5.5K	7.5K	
		0008	0015	0030	0050	0080	0110	0175	0240	0330	
Output	Rated current (A) ^{*3}	0.8 (0.8)	1.5 (1.4)	3.0 (2.5)	5.0 (4.1)	8.0 (7.0)	11.0 (10.0)	17.5 (16.5)	24.0 (23.0)	33.0 (31.0)	
	Overload current rating ^{*4}	150% 60 s, 200% 3 s (inverse-time characteristics) at an ambient temperature of 50°C									
Power supply	Rated input: AC (DC) voltage/frequency	3-phase 200 to 240 V, 50/60 Hz									
	Allowable range of AC (DC) voltage fluctuation	170 to 264 V, 50/60 Hz									
	Allowable range of frequency fluctuation	±5%									
Enclosure rating (IEC 60529)		Open structure (IP20)									
Cooling method		Self-cooling					Forced air cooling				
Approximate mass (kg)		0.5	0.5	0.7	1.0	1.4	1.4	1.8	3.3	3.3	

3-phase 400-V power supply

Model name: FR-E840-[]		0.4K	0.75K	1.5K	2.2K	3.7K	5.5K	7.5K	
		0016	0026	0040	0060	0095	0120	0170	
Output	Rated current (A) ^{*3}	1.6 (1.4)	2.6 (2.2)	4.0 (3.8)	6.0 (5.4)	9.5 (8.7)	12.0	17.0	
	Overload current rating ^{*4}	150% 60 s, 200% 3 s (inverse-time characteristics) at an ambient temperature of 50°C							
Power supply	Rated input: AC (DC) voltage/frequency	3-phase 380 to 480 V, 50/60 Hz							
	Allowable range of AC (DC) voltage fluctuation	323 to 528 V, 50/60 Hz							
	Allowable range of frequency fluctuation	±5%							
Enclosure rating (IEC 60529)		Open structure (IP20)							
Cooling method		Self-cooling				Forced air cooling			
Approximate mass (kg)		1.2	1.2	1.4	1.8	1.8	2.4	2.4	

*3: When the Pr.72 PWM frequency selection is 2 kHz or higher and low-noise operation is performed at an ambient temperature exceeding 40°C, the rated output current is the figure in ().

*4: The % value for overload current rating is the percentage relative to the inverter rated output current. When using repeatedly, it is necessary to wait until the inverter and motor return to or below the 100% load temperature.

Outline dimensional drawings

FR-E820-0.1K to 0.75K

When built-in option is mounted

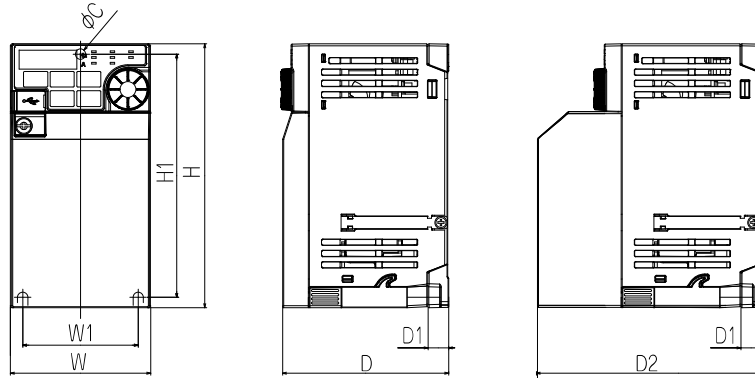

FR-E820-1.5K to 7.5K
FR-E840-0.4K to 7.5K

When built-in option is mounted

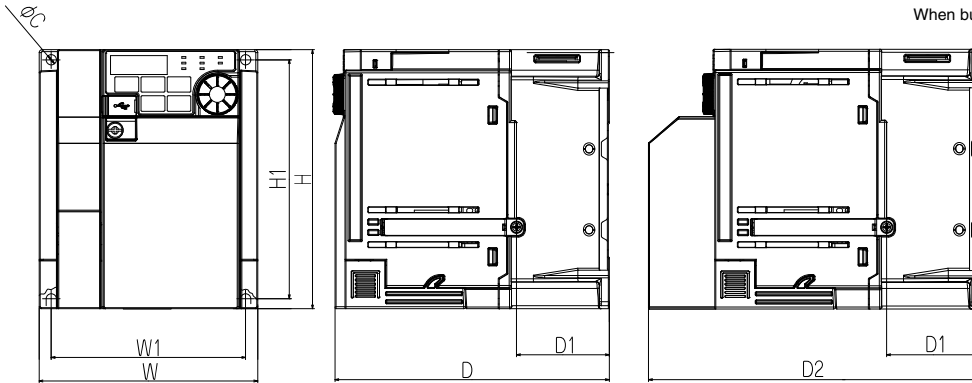

● 3-phase 200 V class

(Unit: mm)

Inverter model name	W	W1	H	H1	D	D1	D2	C
FR-E820-0.1K	68	56	128	118	80.5	10	108.1	5
FR-E820-0.2K					112.5	42	140.1	
FR-E820-0.4K					132.5		160.1	
FR-E820-0.75K					135.5	46	163.1	
FR-E820-1.5K	108	96	260	244	142.5	52.5	170.1	6
FR-E820-2.2K	140	128			165	71.5	192.6	
FR-E820-3.7K	180	164						
FR-E820-5.5K								
FR-E820-7.5K								

● 3-phase 400 V class

(Unit: mm)

Inverter model name	W	W1	H	H1	D	D1	D2	C
FR-E840-0.4K	108	96	128	118	129.5	40	157.1	5
FR-E840-0.75K						46	162.6	
FR-E840-1.5K						43.5	162.6	
FR-E840-2.2K	140	128	150	138	135	68	174.6	5
FR-E840-3.7K	220	208	150	138	147	68	174.6	
FR-E840-5.5K								
FR-E840-7.5K								

FREQROL-E700EX

Small and sophisticated drive modules



Lineup

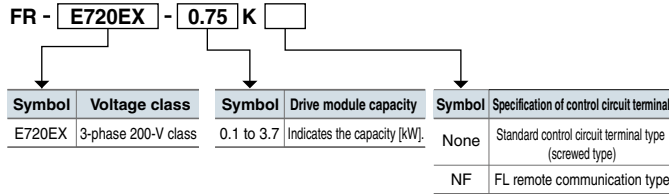

Conforming to UL (UL508C), cUL (CSA C22.2 No.14), EC Directive (CE mark) and Radio Waves Act (Republic of Korea) *1

Human- and environment-friendly drive modules conforming to RoHS Directive.

*1 The products compatible with FL remote communication do not conform to the Radio Waves Act (Republic of Korea).

Rating

3-phase
200-V power supply

Model name: FR-E720EX-□K(NF)		0.1	0.2	0.4	0.75	1.5	2.2	3.7
Output	Rated current (A)	0.8	1.5	3	5	8	11	17.5
	Overload current rating	150% 60 s, 200% 3 s (based on motor rated current, inverse-time-limit characteristic)						
Power supply	Rated input AC voltage/frequency	3-phase, 200 to 240 V, 50 Hz/60 Hz						
	Allowable range of AC voltage fluctuation	170 to 264 V, 50 Hz/60 Hz						
	Allowable range of frequency fluctuation	±5%						
Enclosure rating	Closed type (IP20) *2							
Cooling method	Self-cooling				Forced air cooling			
Approximate weight (kg)	0.5	0.5	0.7	1.0	1.4	1.4	1.7	

*2 The products compatible with FL remote communication are open type (IP00).

Outline dimensional drawings

FR-E720EX-0.1K(NF) to 0.75K(NF)

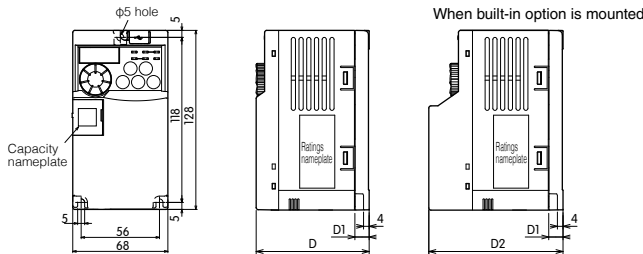

(Unit: mm)

Drive unit model name	D	D1	D2	
			When FR-A7NC E kit is mounted	When FR-E7DS is mounted
FR-E720EX-0.1K and -0.2K	80.5	10	97.6	108
FR-E720EX-0.1KNF and -0.2KNF	89.5		—	—
FR-E720EX-0.4K	112.5	42	129.6	140
FR-E720EX-0.4KNF	121.5		—	—
FR-E720EX-0.75K	132.5	62	149.6	160
FR-E720EX-0.75KNF	141.5		—	—

FR-E720EX-1.5K(NF) and -2.2K(NF)

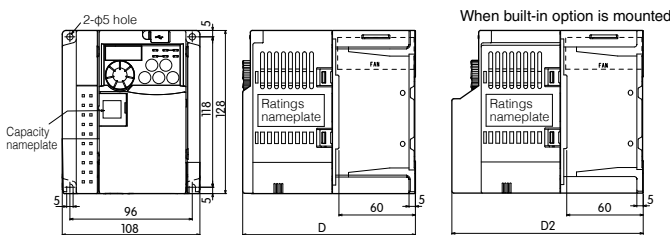

(Unit: mm)

Drive unit model name	D	D2	
		When FR-A7NC E kit is mounted	When FR-E7DS is mounted
FR-E720EX-1.5K and -2.2K	135.5	152.6	163
FR-E720EX-1.5KNF and -2.2KNF	144.5	—	—

FR-E720EX-3.7K(NF)

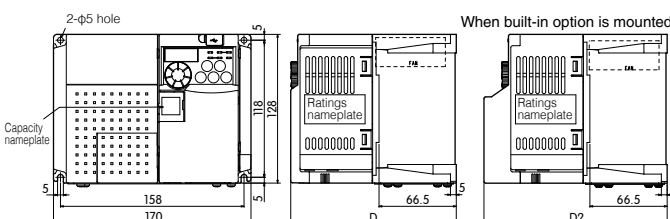

(Unit: mm)

Drive unit model name	D	D2		
		When FR-A7NC E kit is mounted	When FR-E7DS is mounted	When FR-A7AP-EX kit is mounted
FR-E720EX-3.7K	142.5	159.6	170	157.6
FR-E720EX-3.7KNF	151.5	—	—	—

* For the details of the drive modules, see the general catalog of sensorless servos (L(NA)06083-E(1703)MEE).

1

Operating in the speed control mode

The motor can be operated at a specified speed with an external operation switch.

3-speed operation can be performed with an external operation switch.

* Setting multiple speeds (up to 15) is also possible.

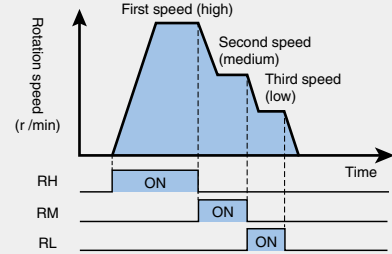

Operation procedure

1	Screen displayed when power is turned on	The monitor screen appears.
2	Speed setting	Turn on the high speed switch (RH).
3	Start → Acceleration → Constant speed	Turn on the start switch (STF or STR). The speed indicated on the display area will increase with the acceleration time Pr.7 and reach "3000" (3000 r/min). The [RUN] lamp is on during normal rotation and flashing during reverse rotation. ● When RM has been turned on, 1500 r/min is displayed. When RL has been turned on, 300 r/min is displayed.
4	Deceleration → Stop	Turn off the start switch (STF or STR). The speed indicated on the display area will decrease with the deceleration time Pr.8 and reach "0" (0 r/min), and the motor will stop. The [RUN] lamp will go out.
5	Speed setting (OFF)	Turn off the high speed switch (RH).

2

Operating in the position control mode

Position control can be performed without a sensor, and the motor can be operated for movement to a specified position with an external operation switch.

Operation example

Positioning operation can be performed with an external operation switch.

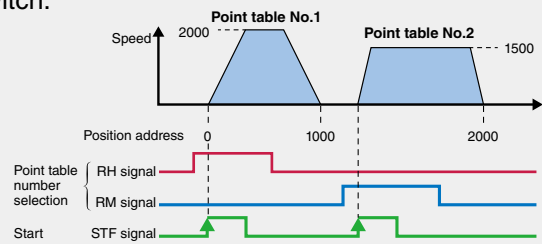

Operation procedure

1	Screen displayed when power is turned on	The monitor screen appears.
2	Target position setting	Turn on the high speed switch (RH).
3	Servo on (origin point return)	Turn on the low speed switch (SON).
4	Positioning	Turn on the start switch (STF). The motor will run until the position specified in the point table is reached.
5	Stop	Turn off the start switch (STF).
6	Servo off	Turn off the low speed switch (SON).
7	Target position setting (OFF)	Turn off the high speed switch (RH).

For position control, the speed command is calculated in the way the difference between commanded position and present position is reaching to zero, and then the motor is started.

The position command can be set by the point table method.

The positioning operation can be performed by selecting a position command in the point table with an external operation switch.

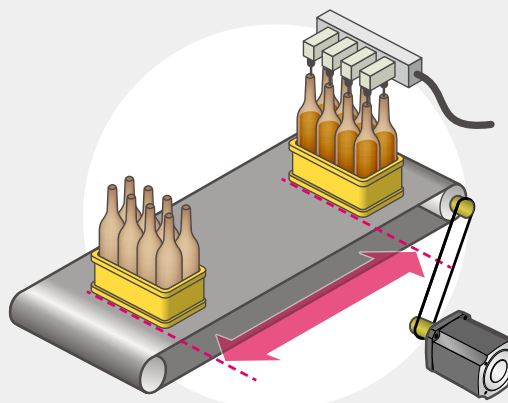

Connection example

Assign the external operation switch functions for position control.

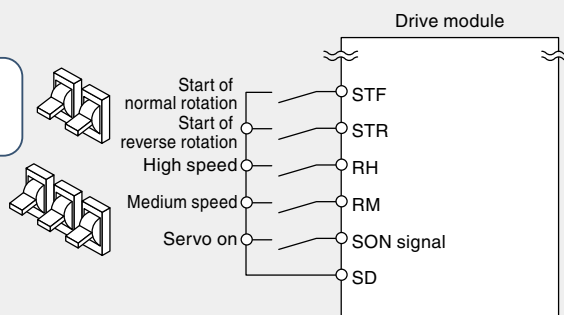

Create the point table.

Item	First positioning	Second positioning
Operating speed	2000r/min(Pr.4)	1500r/min(Pr.5)
Acceleration time	1.0s(Pr.578)	0.5s(Pr.580)
Deceleration time	1.0s(Pr.579)	0.5s(Pr.581)
Target position	1000(Pr.465)	2000(Pr.467)
Auxiliary function for positioning	10: Forward direction Incremental value command Independent (Pr.525)	11: Backward direction Incremental value command Independent (Pr.526)

Item	Setting
Pr.800 Control method selection	13: Position control
Pr.532 Home position return method	2: Data set method
Pr.537 Roll feed mode selection	1

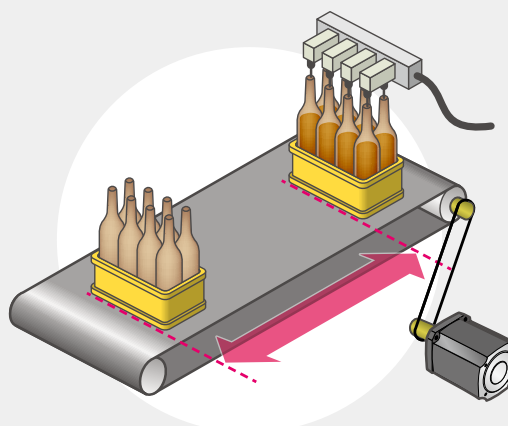

* The parameter numbers are for the FR-E700EX. For details, see the instruction manual for the drive module.

3

Introduction of positioning modules

An example of combination with a positioning module is introduced.

Operation example

Positioning by pulse-train input can be performed by combining FR-A7AP-EX (built-in option) and a programmable controller positioning module.

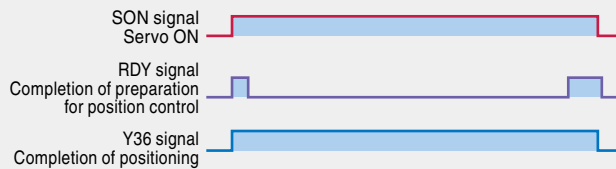
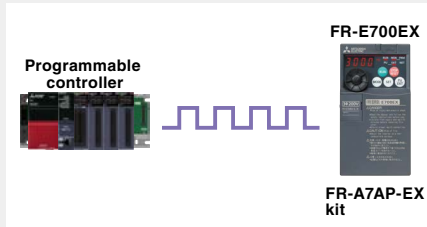
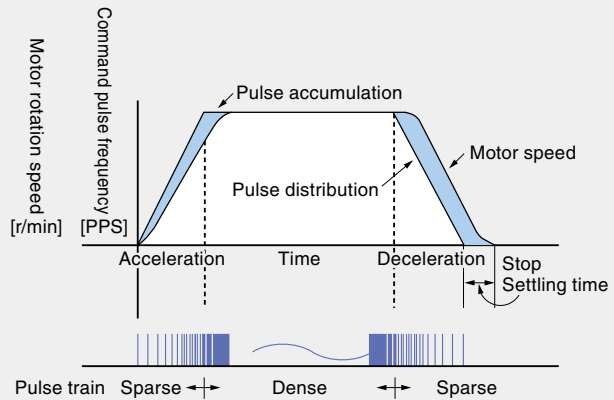

Wiring example Example of wiring of FR-A7AP-EX (built-in option) and positioning module

Connection with MELSEC iQ-R Series RD75D positioning module

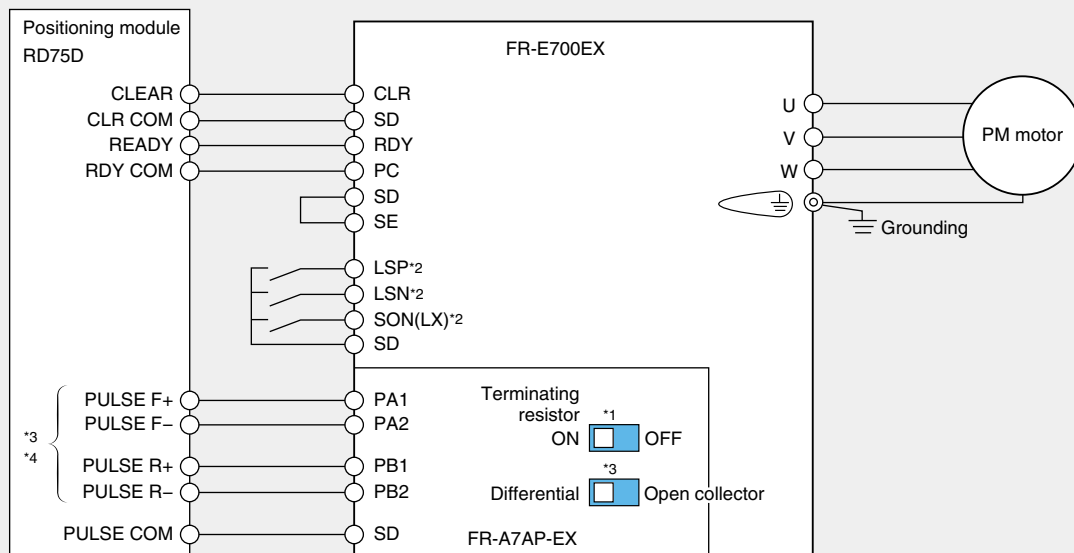

*1 When an open collector is used, set the terminating resistor selector switch to OFF (default).

*2 Assign the functions with Pr.178 to Pr.184 (input terminal function selection).

*3 The connection varies depending on the specifications for the pulse signals input from the positioning module. (This figure gives an example of connection with a differential line driver.)

*4 When Pr.428 (command selection) is not set to "1,4," connect the positioning module terminals (PULSE F+, PULSE F-, PULSE R+ and PULSE R-) and the terminals of FR-A7AP-EX (PA1, PA2, PB1 and PB2) as shown in the wiring example.

When Pr.428 is set to "1,4," connect the terminals PULSE R+ and PA1, PULSE R- and PA2, PULSE F+ and PB1, and PULSE F- and PB2.

Application examples

1 Transport application

Positioning is possible without a sensor (encoder)

Other features

- Improved work speed and stopping accuracy.
- Not subject to high-efficiency laws and regulations of various countries, and can be used safely for overseas projects.

After

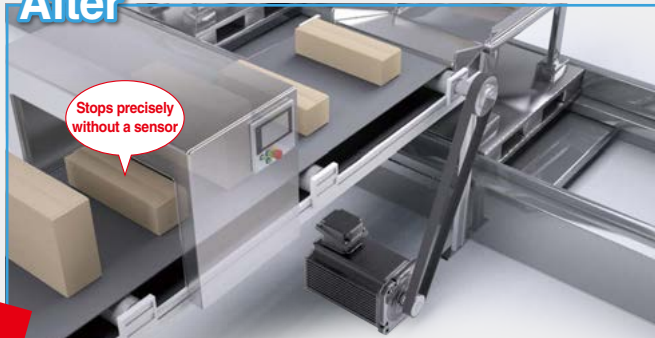

Before

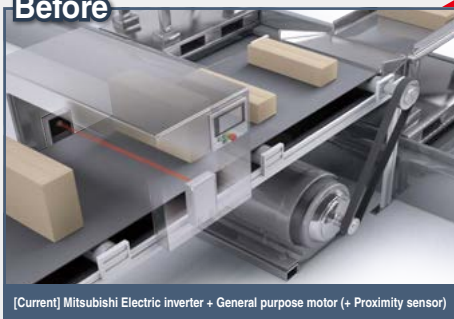

[Suggested] FR-E800 + EM-A

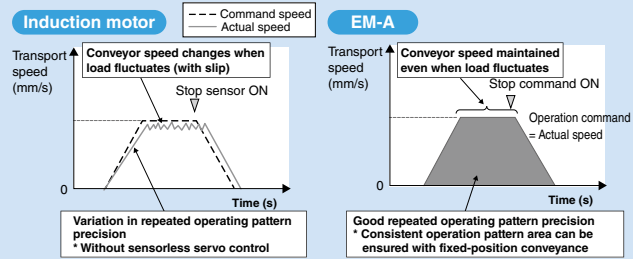

2 Pump application

Torque in the low speed range

Maximum torque is*
200%

- The speed control range is wide and the torque is good even at low speeds. (Speed control range 1000)

*1: The indicated maximum torque (200%) is for 3-phase inverter power specifications.

High precision speed control

Speed fluctuation rate is
±0.05%
*For digital input

- Compared to induction motors, these new motors provide high precision speed control with less speed fluctuation.

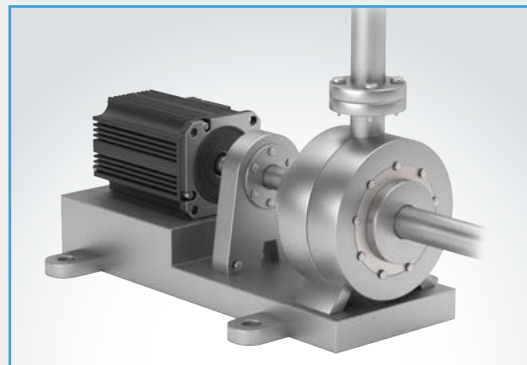

- The EM-A Series realizes high-precision speed control by using Mitsubishi Electric's unique PM sensorless vector control that does not cause significant speed variations even under changing loads.
- These motors can operate at stable speeds that are resistant to load fluctuations.

[Operating torque characteristics]

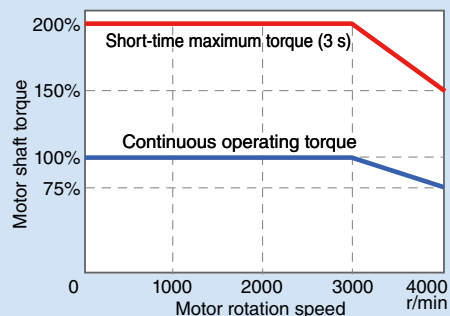

Warranty

1. Warranty period and scope

In the event of a failure in the product which is the fault of our company occurring during the warranty period, Mitsubishi will provide free repair of the product through the dealer where the product was purchased or our service company. However, if it is necessary to dispatch a repair technician from Japan to an overseas destination, or to a remote island or equivalent distant destination, the customer will be charged the actual expenses required for technician dispatch.

[Warranty period]

The warranty period shall end either when 1 year has passed after installation at your company or the customer of your company, or 18 months after shipping from our factory (calculated starting from the date of manufacture), whichever period is shorter. The warranty period for a repaired part will not be extended beyond the pre-repair warranty period.

[Warranty scope]

(1) Failure diagnosis

Initial failure diagnosis shall in general be performed by your company. However upon request from your company, this work can be performed for a fee by Mitsubishi or our service network. In this case, if the results of discussion with your company conclude that Mitsubishi bears responsibility for the cause of the failure, then the charge for this diagnosis work will be waived but only in relation to the current product repairs or provision of replacement parts.

(2) Warranty contents

Even during the warranty period, a fee will be charged for repairs, part replacement, and technician dispatch in case of the following failures.

- (i) Failures caused by a problem in the installation or connection of equipment or other items that was performed by your company or a customer of your company
- (ii) Failures resulting from use of a lubrication oil other than that recommended by Mitsubishi
- (iii) Failures caused by factors such as inappropriate storage or handling, inattention, negligence, or the equipment and systems of your company
- (iv) Failures caused by modification or other changes to Mitsubishi products that were performed by your company
- (v) Failures caused by use of Mitsubishi products outside of the specification ranges
- (vi) Failures occurring when the conditions of use were normal but which may be regarded as preventable by performing the regular maintenance or replacement of consumable parts (bearings, oil seals, etc.) that is prescribed in the instruction manual or other documents
- (vii) Failures caused by unpreventable external factors such as fire or abnormal voltage, or by earthquake, lightning, wind or flood damage, or other natural disaster
- (viii) Failures resulting from a cause which could not have been predicted given the level of science and technology at the time the product was shipped from Mitsubishi
- (ix) Other failures recognized as not being the responsibility of Mitsubishi

The above services are provided only within Japan. Please refrain from requesting failure diagnosis and other services from overseas.

2. Exclusion of opportunity losses, secondary losses, and similar losses from warranty coverage

Regardless of whether within or outside of the warranty period, Mitsubishi shall bear no liability for any of the following occurring at your company, the customers or your company, or elsewhere on your company's side as a result of a failure of a Mitsubishi product: opportunity losses and loss of income; damages resulting from exceptional circumstances regardless of whether or not they were predicted by Mitsubishi; transport, interruption of business, and other secondary losses; accident compensation; damage to products other than Mitsubishi products; and other compensation for operations.

Be aware that the specifications listed in catalogs, instruction manuals, and technical materials may be changed without notice.

3. Repair period after the stop of production

For models (products) where production was stopped, repairs and supply of parts will be provided for a period of 7 years following the month in which production was stopped. However, be aware that parts which are produced using casting or forming molds may be replaced by parts that have equivalent functions.

The supply of products, including replacement products, will not be possible following the stop of production.

4. Changes to product specifications

Be aware that the specifications listed in catalogs, instruction manuals, technical materials, and other documents may be changed without notice.

5. Applications of the product

- (1) Use of the product is limited to applications where a failure or problem in the product will not result in a severe accident, and its use is permitted only when backups and failsafe functions have been systematically implemented in case a failure or problem occurs.
- (2) The product was designed and manufactured as a general-purpose product for ordinary industrial and other applications. Therefore, the product must not be used in applications which require a special quality assurance system, such as in nuclear power plants and other power plants operated by power companies, and other applications that have a large impact on the public, or in applications for railway companies or government offices. The product must not be used in applications which can be expected to have a large effect on lives or property, such as aviation, medical care, railways, combustion and fuel systems, manned transport systems, entertainment equipment, or safety equipment. However, when the customer understands and accepts that it cannot require any special quality for a particular application, Mitsubishi will consider permitting use in such applications. Please contact our office.

Creating Solutions Together.



Low-voltage Power Distribution Products



Transformers, Med-voltage Distribution Products



Power Monitoring and Energy Saving Products



Power (UPS) and Environmental Products



Compact and Modular Controllers



Servos, Motors and Inverters



Visualization: HMIs



Edge Computing Products



Numerical Control (NC)



Collaborative and Industrial Robots



Processing machines: EDM, Lasers



SCADA, analytics and simulation software

Mitsubishi Electric's product lineup, from various controllers and drives to energy-saving devices and processing machines, all help you to automate your world. They are underpinned by software, innovative data monitoring, and modelling systems supported by advanced industrial networking and Edgecross IT/OT connectivity. Together with a worldwide partner ecosystem, Mitsubishi Electric factory automation (FA) has everything to make IoT and Digital Manufacturing a reality.

With a complete portfolio and comprehensive capabilities that combine synergies with diverse business units, Mitsubishi Electric provides a one-stop approach to how companies can tackle the shift to clean energy and energy conservation, carbon neutrality and sustainability, which are now a universal requirement of factories, buildings, and social infrastructure.

We at Mitsubishi Electric FA are your solution partners waiting to work with you as you take a step toward the realization of sustainable manufacturing and society through the application of automation. Let's automate the world together!



mitsubishi **ELECTRIC CORPORATION**
HEAD OFFICE: TOKYO BLDG., 2-7-3, MARUNOUCHI, CHIYODA-KU, TOKYO 100-8310, JAPAN